

data sheet: H7G60

Kroepelin GmbH
Gartenstraße 50
D-36381 Schlüchtern

Tel.: 06661 86 0
Fax: 06661 86 39
Mail: sales@kroepelin.com
Web: www.kroepelin.com

Kroepelin
Längenmesstechnik

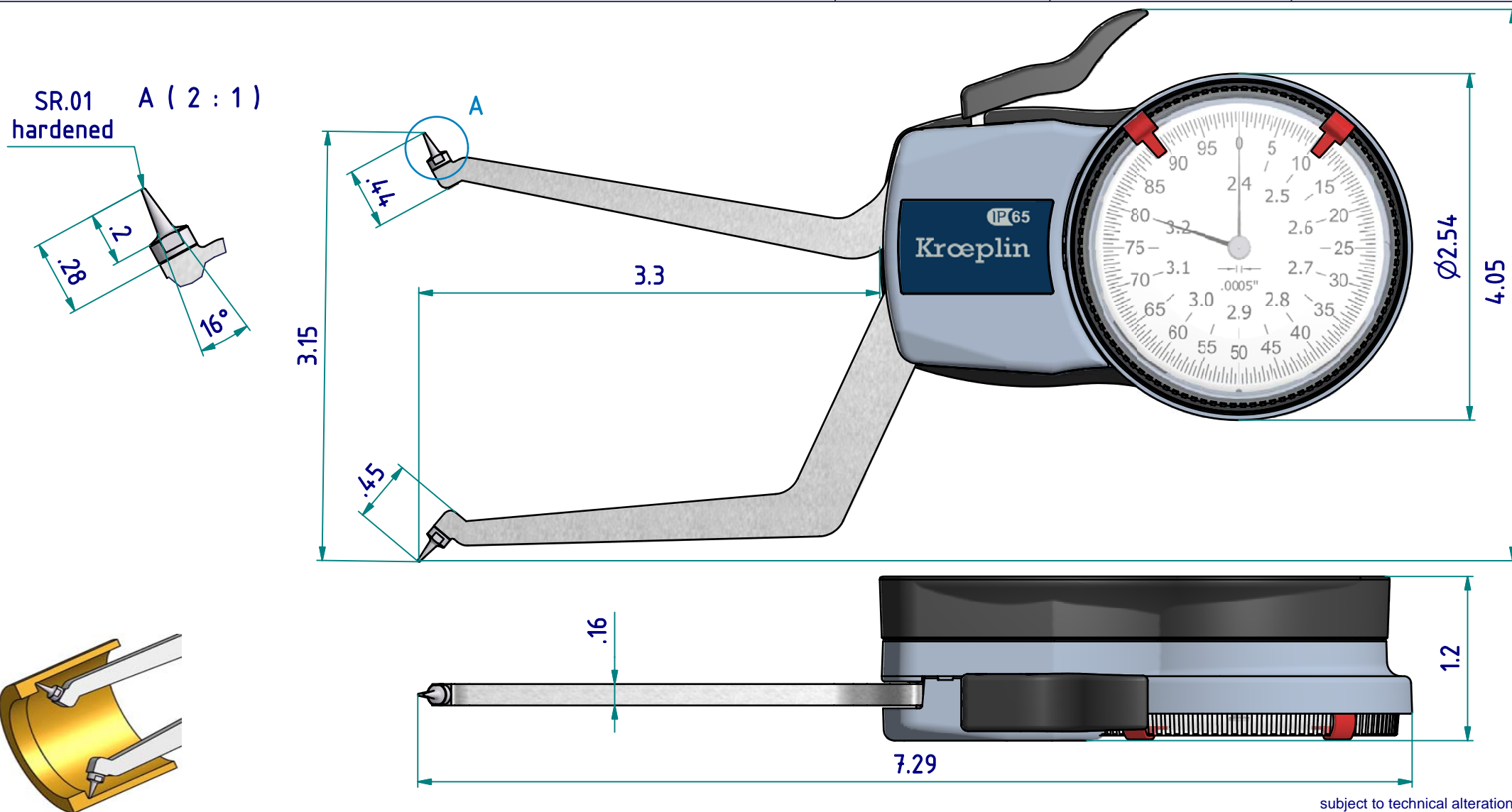

subject to technical alterations

type: H
range: 2.40 - 3.20 INCH
range of indication: 2.38 - 3.21 INCH
digital step: -
scale interval: .0005 INCH
measuring force: 1,1 - 1,6 N
weight: 200 g

acceptable deviations
VDI/VDE/DGQ 2618 Bl. 12.1/13.1)
max. permissible errors "G": .0015 INCH
repeatability "r": .0005 INCH
reference temperature: 20° C
operation temperature: 10° C - 30° C
storage temperature: -10° C - 50° C

scale: 1:1
drawing-nr.: DAB-H7G60_KR_I
date of issue: 14.01.09
name: T.Koenig
revision status:
revision date: